



 **CELESTRON**  
**NEXSTAR**

**EVOLUTION**

# INSTRUCTION MANUAL

Models #12090 (NexStar Evo 6), 12091 (NexStar Evo 8), 12092 (NexStar Evo 9.25)



## Table of Contents

What's in the Box . . . . .	5
Assembly and Setup . . . . .	7
Getting Started – Using Your Smart Device . . . . .	10
Aligning the NexStar Evolution with SkyPortal App . . . . .	10
Pointing to Objects in SkyPortal and other Telescope Functions . . . . .	11
SkyPortal Telescope Setup and Control Menu . . . . .	13
Getting Started – Using the NexStar+ Control . . . . .	15
Overview of Two Popular Alignment Methods . . . . .	16
Using a Wedge with EQ North / EQ South Alignment . . . . .	17
NexStar Evolution Telescope Settings in NexStar+ Hand Control . . . . .	18
NexStar+ Hand Control for NexStar Evolution Menu Tree. . . . .	19
Advanced Menu Tree . . . . .	20
Telescope Maintenance . . . . .	21
Appendix A: Specifications . . . . .	23
Appendix B: Advanced WiFi . . . . .	25
Appendix C: L.E.D. Status . . . . .	26
Celestron Two Year Limited Warranty. . . . .	26



# WHAT'S IN THE BOX

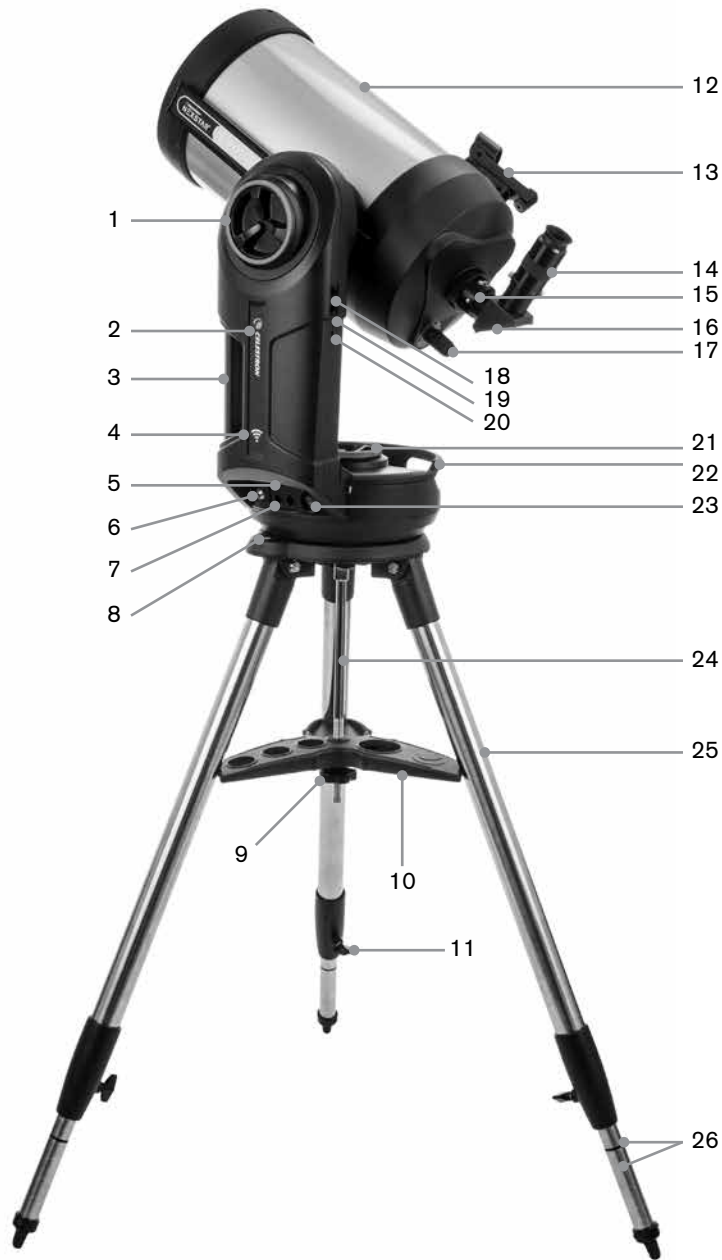

1	Altitude Clutch Knob
2	Power & Charging L.E.D.
3	Carry Handle
4	WiFi L.E.D.
5	USB Power Output Port
6	Power Input Port
7	Auxiliary Ports 3 & 4
8	Bubble Level
9	Tripod Support Nut and Washer
10	Accessory Tray
11	Leg Height Adjustment Lock Knob
12	Telescope Optical Tube
13	StarPointer Red Dot Finder
14	Eyepiece
15	Visual Back
16	Star Diagonal
17	Focus Knob
18	Auxiliary Ports 1 & 2
19	WiFi Switch
20	Reset Switch
21	Azimuth Clutch Knob
22	Carry Handle
23	Power Switch
24	Central Column
25	Tripod
26	Leg Height Index Marks

## PARTS LIST

Optical Tube Assembly  
 1.25" Star Diagonal  
 40mm Plössl Eyepiece  
 13mm Plössl Eyepiece  
 StarPointer Red Dot Finderscope  
 Fork Mount  
 Tripod  
 Accessory Tray  
 AC Adapter with USA, EU, UK and AU plugs

## PREREQUISITES

---

- AC outlet to charge the telescope with the supplied AC power adapter.
- An Apple iOS device with iOS 7.0 and later or an Android device with Android 4.0 if used without the included NexStar+ hand control.
- Free download of Celestron SkyPortal app from the App Store or Google Play if used without the included NexStar+ hand control.
- Phillips head screwdriver to install the StarPointer red dot finder.

## SOLAR WARNING

---



- Never look directly at the Sun with the naked eye or with a telescope (unless you have the proper solar filter). Permanent and irreversible eye damage may result.
- Never use your telescope to project an image of the Sun onto any surface. Internal heat build-up can damage the telescope and any accessories attached to it.
- Never use an eyepiece solar filter or a Herschel wedge. Internal heat build-up inside the telescope can cause these devices to crack or break, allowing unfiltered sunlight to pass through to the eye.
- Never leave the telescope unsupervised. Make sure an adult who is familiar with the correct operating procedures is with your telescope at all times, especially when children are present.

## BATTERY CAUTION

---

This product contains a long life lithium iron phosphate battery "LiFePO4". The battery includes numerous built-in safety features including protection against overcharging and overdischarging, and overheating. If reasonable care is used, the battery should last thousands of charge cycles without the need to replace it. To benefit from the maximum battery life, note the following recommendations:

- **Charge the battery to full as soon as you receive the telescope.**
- **Only use the included power supply to charge the battery, or an FCC and CE certified 12VDC power supply with at least 2 Amperes of current.**
- **Do not leave the battery fully discharged or low for an extended period of time.**
- **Keep the battery charged every 3 to 6 months.**
- **Do not store the battery above 140°F/60°C.**

# ASSEMBLY AND SETUP

Remove the parts from their shipping cartons and go over all the items in the parts list. Keep all of the original packaging so it can be used to transport the telescope safely.

Set the fork arm mount on a sturdy flat surface. Remove all of the accessories from their individual boxes.

## TRIPOD FOR 6" AND 8" MODELS

1. Spread the tripod legs and stand the tripod upright.
2. Remove the Tripod Support Nut and Washer from the central column attached to the top of the tripod.
3. Place the accessory tray over the central column so that each of the three arms of the tray is touching a tripod leg.
4. Thread the nut and washer back onto the threaded column and firmly tighten into place. The accessory tray should not be able to move against the tripod.
5. Adjust the height of the tripod by loosening the lock knobs on the end of each tripod leg. Then adjust the leg height as needed and retighten the lock knobs, one leg at a time. Note the leg index marks can be used to easily level the tripod.
6. Confirm the tripod is level using the built-in bubble level on the tripod base.

**Helpful Hint:** When transporting the telescope, the tripod can be folded with the accessory tray attached. Loosen the Tripod Support Nut and Washer to allow the accessory tray to drop, then rotate the accessory tray and fold the tripod legs into the slots on the tray.

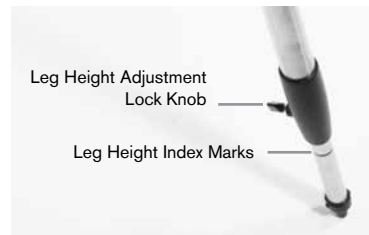
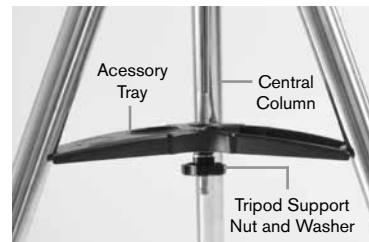

## MOUNT

1. Place the fork arm mount on the tripod, carefully centering the mount over the center post on the tripod head. Do not let go of the mount until it has registered with the center post.
2. With the mount resting on the flat top surface of the tripod head, rotate the mount until the three mounting sockets align. The sockets will click into place, indicating they are aligned.

**Note:** The NexStar Evolution 9.25" model, which uses the larger tripod, does not click into place.

3. Thread the three attached mounting bolts from underneath the tripod head into the bottom of the telescope base. Tighten all three bolts.



## TELESCOPE OPTICAL TUBE

The 6" optical tube is preinstalled with the telescope. The 8" and 9.25" models require installing the optical tube onto the fork arm mount.

1. Unlock the altitude clutch by loosening the orange altitude clutch lock knob.
2. Rotate the altitude axis until the quick release knob faces downward.
3. Tighten the altitude clutch lock knob.
4. Loosen the quick release knob a couple of turns to allow room for the dovetail on the telescope optical tube.
5. Slide the telescope optical tube into the quick release slot from the back side of the telescope. The fork arm should be on the left side of the optical tube. For correct balance, position the telescope so that you can read the "Evolution" nameplate. If you choose to add different accessories to your telescope, you can rebalance it later.
6. Keep hold of the optical tube and secure it into place by tightening the quick release knob.



## VISUAL ACCESSORIES

### *Star Diagonal*

The included star diagonal diverts the light at a right angle to the light path of the telescope. This allows you to observe in positions that are physically more comfortable than if you looked straight through. Note that images observed through a right angle star diagonal are right-side-up, but mirror inverted.

### *Eyepiece*

The eyepiece is the optical element that magnifies the image focused by the telescope. The eyepiece fits into the star diagonal. Two eyepieces are included with the NexStar Evolution. You should always start with the lower power 40 mm eyepiece to find and center objects.

Remove all the dust caps from the star diagonal, 40 mm eyepiece, and the dust cap on the visual back of the telescope.



### *Eyepiece and Diagonal*

1. Insert the mirror star diagonal into the visual back of the telescope and secure it into place by tightening the two set screws on the visual back.
2. Insert the 40 mm eyepiece into the mirror star diagonal and secure it into place by tightening the two set screws on the diagonal.

### *StarPointer Red Dot Finder*

1. Loosen the two Phillips head screws on the StarPointer's dovetail clamp slightly using a screwdriver.
2. Slide the StarPointer over dovetail rail preinstalled on the telescope. (*See StarPointer Overview*)
3. Tighten the two Phillips head screws to secure the finder in place.



## ALIGNING THE STARPOINTER RED DOT FINDERSCOPE

---

The StarPointer is powered by a long life 3-volt lithium battery (#CR2032) located underneath the front portion of the StarPointer. The StarPointer must be properly aligned with the telescope before it can be used. This is a simple process using the azimuth and altitude control knobs located on the side and bottom of the StarPointer. The alignment procedure is best done at night since the LED dot will be difficult to see during the day.

1. Turn on the StarPointer by rotating the variable brightness control clockwise until you hear a click. To increase the brightness level of the red dot, continue rotating the control knob about 180° until it stops.
2. Locate a bright star or planet and center it using the 40 mm eyepiece in the telescope.
3. With both eyes open, look through the glass window in the StarPointer.
4. If the StarPointer is perfectly aligned, you will see the red LED dot overlap the alignment star. If the StarPointer is not aligned, take notice of where the red dot is relative to the bright star.
5. Without moving the main telescope, turn the StarPointer's azimuth and altitude alignment controls until the red dot is directly over the alignment star.

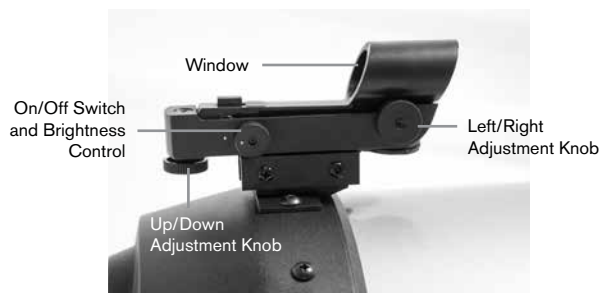

## THE ALTITUDE AND AZIMUTH CLUTCHES

---

NexStar Evolution features manual clutches that allow you to manually move the altitude (up/down) and azimuth (left/right) axis without using the motors. This can be useful for daytime terrestrial use or when storing the telescope.

**Note:** You should not unlock the clutches when the telescope is aligned with the app or hand control, or the alignment will be lost. The telescope accounts for movement made by the motors. If the telescope is moved manually or bumped after it was aligned, you should perform a new alignment.

This is the recommended starting position of the telescope, but is not required:

1. Unlock the altitude clutch knob and position the telescope so that it's perpendicular to the fork arm base, then retighten the altitude clutch knob.
2. Unlock the azimuth clutch knob and position the telescope so that it's aimed towards an unobstructed horizon, then retighten the azimuth clutch knob.

## THE WIFI AND RESET SWITCHES

---

WiFi can be toggled between Direct Connect and Access Point modes. A small flat head screwdriver or ballpoint pen can be used to access the switch. Direct Connect is used to connect directly to your smart device. Access Point mode is used to connect to your home network through a router. Refer to Appendix B, Advanced WiFi for more information.

**The WiFi switch should always be in the UP position for normal use.**

The reset switch can be accessed using a ballpoint pen. The reset switch should normally not be used except in the unlikely event the telescope becomes unresponsive after cycling the power switch.



## GETTING STARTED – USING YOUR SMART DEVICE

Now that your telescope is assembled and the StarPointer is aligned, let's connect it to your smartphone or tablet. We recommend you familiarize yourself with the telescope and app during the day before using it at night.

**Caution:** Remember to never point the telescope at the Sun during the day without using a proper full aperture solar filter!

1. Turn the power switch to the ON position (ON=1 OFF=0). The Celestron logo LED will light up indicating the telescope is on. The WiFi LED will also blink indicating WiFi ready status.
2. Go to your device's WiFi settings, and connect to the "SkyQLink-xx" network that your telescope is broadcasting. Wait for your device to confirm that you have successfully connected.
3. Launch Celestron SkyPortal on your device and select "Connect." Arrows will appear on your screen for UP/DOWN and LEFT/RIGHT. These motions are referred to as altitude and azimuth, respectively.
4. Use the arrows to move your telescope. A slider will adjust the motor speed. Start by pointing at distant terrestrial objects. Locate something with your StarPointer first, then look at the object using the 40 mm eyepiece. Switch to the 13 mm eyepiece, and notice how it increases the magnification and decreases the field of view. When you change eyepieces, you may have to readjust the focus slightly to get the sharpest image. Now that you are familiar with your telescope, you are ready to begin observing the night sky!

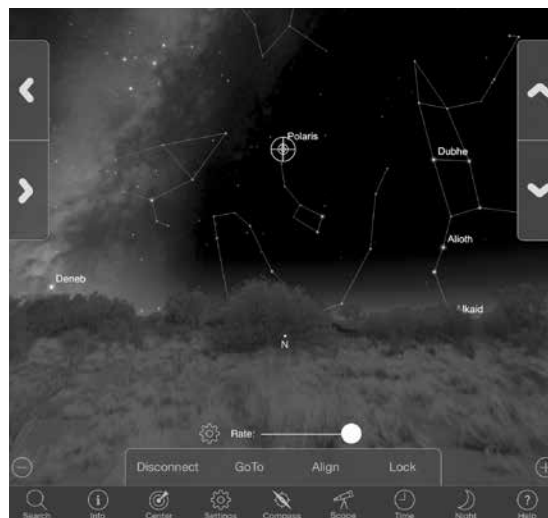
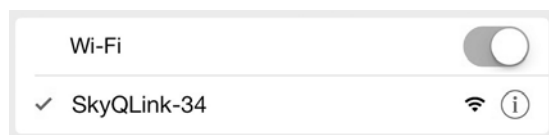

## ALIGNING THE NEXSTAR EVOLUTION WITH CELESTRON SKYPORTAL

Your telescope must be aligned before it can accurately point to celestial objects in the sky. Once aligned, your telescope will automatically locate any celestial object you select on your screen! The telescope also automatically tracks objects in the sky as the Earth rotates. This keeps objects centered in the eyepiece, and makes it easy to share views with family and friends.

SkyPortal's default alignment uses Celestron's SkyAlign™ technology which only requires centering any three bright stars in the sky, without having to know their names. And since your smart device already accounts for date, time and location, there is no need for GPS or to input information about your observing site. All you have to do is center and align 3 bright stars seen in the sky.

SkyPortal's advanced mount-modeling provides improved pointing accuracy compared to standard computerized hand control systems for telescopes. This level of pointing accuracy was previously only available when used with a dedicated PC running specialized software.

1. Set up your telescope as you did during the day. Make sure your star diagonal and 40 mm eyepiece are installed. Set the tripod to a comfortable height and level it. Turn the telescope on.
2. Connect to the “SkyQLink-xx” WiFi network. Open the SkyPortal app. Select the telescope icon at on your screen, then press “Connect and Align”.

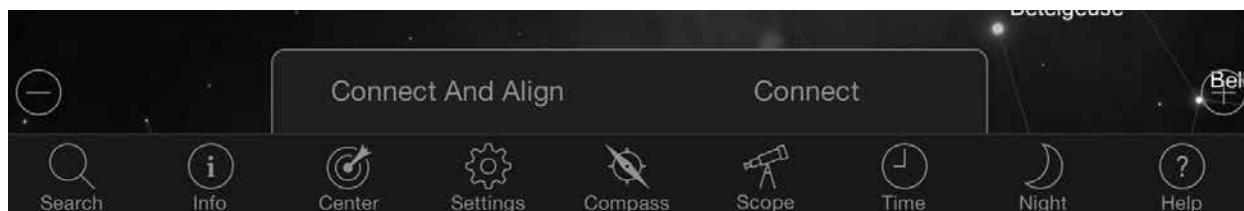

3. Use the arrows on your screen to move the telescope to any bright star in the sky.
4. Center the object in your StarPointer and tap Enter. Now that the object is centered in the finder, the motor speed will slow down so that you may make gradual adjustments to center it in the eyepiece.
5. Center the star in your eyepiece and tap Align. This aligns your first star.
6. Choose another bright star, in a different part of the sky. Move the telescope to the second star and repeat steps 3-5.
7. Repeat this process for a third star in another part of the sky. Upon completing the third alignment star, your telescope will be aligned. You are now ready to observe!

**Helpful Hint:** You can align your telescope during the day by aligning to any visible celestial object. Tap the Settings icon, then tap Telescope Setup and Control, and select “Align Using Manual Align.” Now position the telescope to an object visible during the day – such as the Sun (only with a proper full aperture solar filter!), the Moon, or Venus. After one object is aligned, tap “Done” to complete the alignment. Your telescope’s pointing accuracy will not be as precise as with a typical three point alignment. However, this alignment is suitable for daytime observing and tracking objects.

## POINTING TO OBJECTS IN SKYPORTAL AND OTHER TELESCOPE FUNCTIONS

### GOTO

Now that your NexStar Evolution is aligned, SkyPortal will guide you through the most interesting objects to look at using its interactive planetarium. Your screen displays a detailed star map, which automatically adjusts as you move around. Select the compass icon on your screen and the star map will sync with the sky. Hold your device up to the sky, and you will easily be able to identify bright stars, constellations, planets and deep space objects outside of our Solar System.

SkyPortal will point your telescope at any of these objects. Simply tap the object on your screen, and select “GoTo.” You can also select the search icon to enter an object name, such as “Orion Nebula”, “Jupiter”, or “Pleiades.” Objects may also be entered by their catalog designation, such as M42, M45, NGC 2244, etc.

Another way to find objects of interest is to tap the Search icon and select from “Tonight’s Best.” Select an object from the list, then tap GoTo.

### CONNECT VS CONNECT AND ALIGN

In SkyPortal’s telescope control screen, you can either “Connect” or “Connect and Align.” Selecting “Connect” will resume the previous alignment. If the telescope is used for the first time, the “Connect” option will only give you the ability to move the telescope but it will not yet point to objects without performing an alignment.

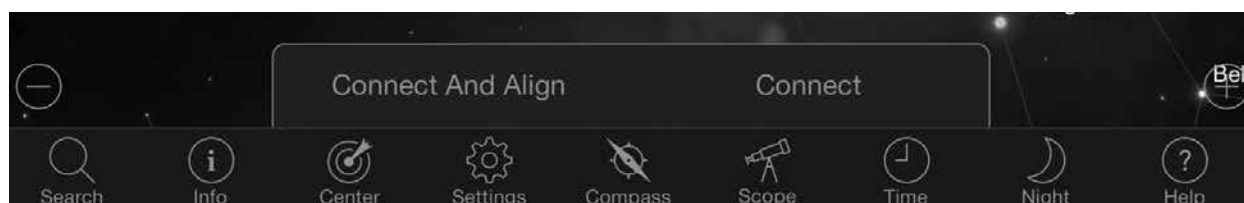

Connect is useful if you keep the telescope set up and close the app, or walk out of WiFi range, then return to the telescope later to resume the alignment.

Connect and Align will start a new alignment. The default uses SkyAlign™ which requires centering any three bright stars in the sky.

**Note:** Any time “Connect and Align” is tapped, the previous alignment will be erased and you must start a new alignment to accurately point to objects.

## DISCONNECT

---

Disconnects the app only from the telescope. The WiFi can remain connected to your smart device, even if you are disconnected in the app. If the telescope remains on, you can reconnect by tapping “Connect” and resume your previous alignment.

## MOTOR SPEED RATE SLIDER BAR

---

Drag the slider bar to change the slew speed of your telescope. The two faster speeds on the right move the telescope so the up/down and left/right orientation matches what you see in the StarPointer. The two slower speeds on the left move the telescope so the up/down and left/right orientation matches what you see in the eyepiece.

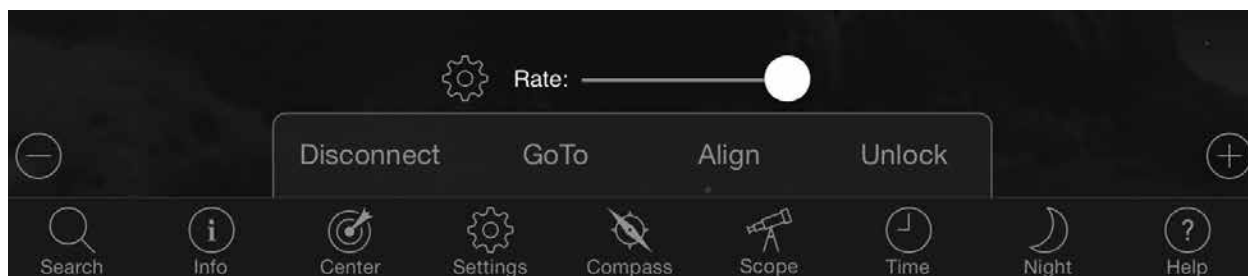

## LOCK AND UNLOCK

---

When connecting to the telescope, the crosshairs on your screen are aligned to the telescope. When you move the telescope with the on-screen direction arrows, the crosshairs remain locked in the center of the screen, causing the sky to scroll by on your display. Select “Unlock” to let the crosshairs move without scrolling the sky. When unlocked, the crosshairs can move off the screen. At any time, you can manually scroll the screen or select “Lock” to re-center the crosshairs.

If you want to explore another region of sky before pointing your telescope, you can scroll away from the current position on your screen at any time, which automatically unlocks the crosshair position. Selecting the Compass icon to sync the display with the sky will also automatically unlock the crosshairs.

## ALIGN

---

Align allows you to add another alignment point to your SkyAlign or Manual align model. The three stars used in SkyAlign or manual align generally provide good accuracy across the sky. Adding alignment stars will further improve the GoTo accuracy. SkyPortal implements advanced mount modeling, which can accommodate up to 10 additional alignment stars. Tap a star on your screen, then tap GoTo. If the star is not centered in your eyepiece, tap Align, then follow the prompts to center your star in the eyepiece and align on it.

# SKYPORTAL TELESCOPE SETUP AND CONTROL MENU

NexStar Evolution contains several telescope control features, such as backlash, and L.E.D. brightness control. The Telescope Setup and Control Menu can be accessed in two different ways. Tap the Settings icon, then tap Scope Setup. Or, when connected to the telescope, simply tap the settings icon located to the left of the speed rate slider bar.

**Note:** You must tap "Done" in the upper right corner of your screen for the setting changes to take effect.

## UTILITIES

- **Battery Status** - Displays the battery voltage, whether it's discharging or charging, and High, Medium, or Low status.
- **Tray Lighting** - Adjusts the LED brightness of the accessory tray light. Light can be turned off by sliding all the way to 0.
- **Logo Lighting** - Adjusts the LED brightness of the Celestron power logo and the WiFi logo. Can be dimmed down or shut off for dark sky locations.

## BEHAVIOR

- **Align Using SkyAlign** - The default and recommended alignment for the NexStar Evolution is SkyAlign. Alignment is achieved by centering and aligning 3 bright stars in the telescope's eyepiece.
- **Align Using Manual Align** - Identify, select, and center 3 named stars in the telescope's eyepiece. The star is selected on your screen and centered with the on-screen direction arrows.
- **Hibernate Enabled** - Allows the telescope alignment to be saved when shutting the telescope off or disconnecting and exiting the app.
- **Max Slew Rate Enabled** - Allows the max slew speed to be adjusted from default.
- **Max Slew Rate** - Increasing speed will draw more battery power. Decreasing speed will operate more quietly.

## TRACKING RATE

- **Sidereal** - Compensates for the rotation of the Earth to keep objects centered in the eyepiece of your telescope. This is the default tracking rate and used for all stars and deep space objects.
- **Lunar** - Used for tracking the Moon and when observing the lunar landscape.
- **Solar** - Used for tracking the Sun when solar observing with a proper filter.
- **Off** - Turns tracking off. The motors in the telescope will stop unless you are slewing.

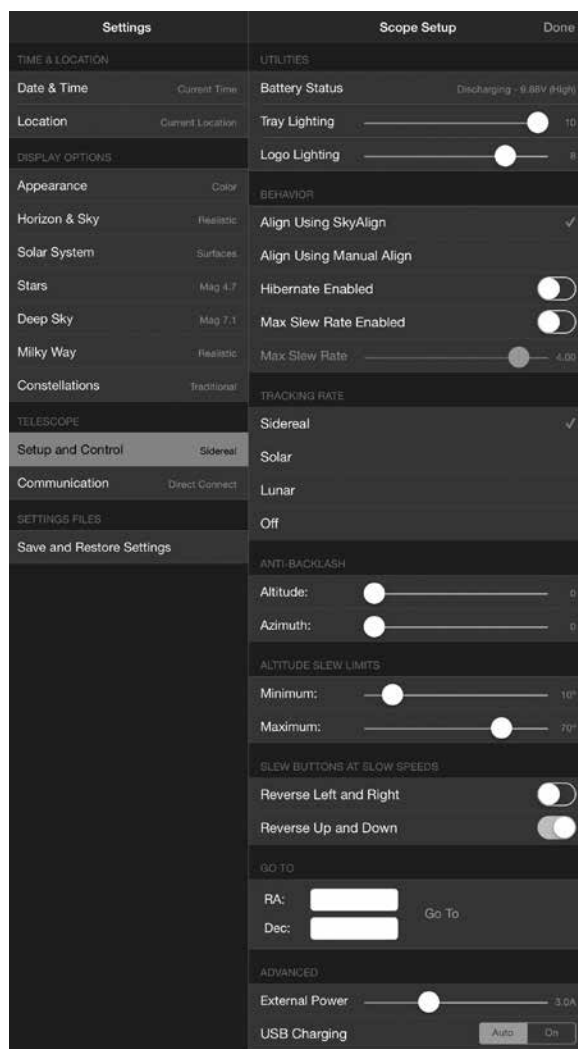

## ANTI-BACKLASH

---

All mechanical gears have a certain amount of backlash or play between the gears. This is seen as a delay in the time it takes for the telescope to move after a direction arrow is pressed, especially when changing directions. Anti-backlash compensates for backlash by inputting a value which quickly rewinds the motors just enough to eliminate the play between gears.

- **Altitude** - Sets the backlash compensation value for altitude (up/down motion of the telescope), 0-99.
- **Azimuth** - Sets the backlash compensation value for azimuth (left/right motion of the telescope), 0-99.

## ALTITUDE SLEW LIMITS

---

The NexStar Evolution used with 6", 8", and 9.25" optical tubes will point straight overhead without obstruction. Using oversized accessories like DSLRs and T-adapters may require limiting the altitude angle to prevent striking the mount. Note that the slew limit does not work until the telescope is aligned with the sky, or the slew limit assumes the telescope is pointing horizontally.

- **Maximum** - Sets the maximum (or highest) limit, 0-90°. Use to prevent the telescope from striking the mount when oversized accessories are attached
- **Minimum** - Sets the minimum (or lowest) limit, 0-90°. This setting is useful when trying to avoid obstructed horizons.

## SLEW BUTTONS AT SLOW SPEEDS

---

Telescope direction can be reversed up/down and left/right to change the apparent motion of the star in the telescope's eyepiece in the three lowest slew speeds. Reverse Up and Down is default enabled so the star moves in the same direction as the direction button.

- **Reverse Left and Right** - Reverses left and right directions in the three lowest slew speeds.
- **Reverse Up and Down** - Reverses up and down directions in three lowest slew speeds.

## ADVANCED

---

Advanced settings in NexStar Evolution allow you to adjust two power management features.

- **External Power** - Sets the maximum potential current draw from the power supply. Default is 2.0A for the included power supply. **Any setting higher than 2.0 requires a higher capacity power supply, which is not included with the telescope.** The telescope has built-in fail safes if the External Power setting is incorrectly set, but we recommend always using a suitable power supply for the given setting.

When used with a higher capacity power supply, this setting allows you to charge the internal battery at the fastest speed while using the telescope, and while optionally charging your smart device from the USB charger.

- **USB Charger** - Sets the USB charger on the mount to always On or Auto. Default is Auto, meaning the charger will shut off to save battery life when the battery is low. On will force the charger to stay on at all times, even when the battery is low.

## GOTO

---

Simply enter the Right Ascension (RA) and Declination (Dec) coordinates to slew to a specified area of sky. This is the quickest way to go to a custom object, such as a new comet or object of interest provided by a star chart or online reference.



The image shows a dark-themed control panel for the 'GOTO' function. At the top, the text 'GO TO' is displayed in a light grey font. Below this, there are two white input fields. The first field is labeled 'RA:' and the second is labeled 'Dec:'. To the right of these fields is a light grey button labeled 'Go To'.

# GETTING STARTED – USING THE NEXSTAR+ CONTROL

This section of the manual can be skipped if you are using a smart device with WiFi instead of the NexStar+ controller.

The NexStar Evolution includes a computerized hand control to operate the telescope directly without the use of the WiFi connection to Celestron SkyPortal. The hand control can be plugged into any of the 4 AUX ports on the mount.

1. **Liquid Crystal Display (LCD) Window:** Has a four-line, 18 character display screen that has red backlighting for comfortable viewing of telescope information and scrolling text.
2. **Align:** Instructs the hand control to begin the process of aligning your telescope.
3. **Direction Keys:** Allows complete control of the mount in any direction. Use the direction keys to center objects in the eyepiece or manually slew telescope.
4. **Catalog Keys:** The mount has a key on the hand control to allow direct access to each of the main catalogs in its 40,000+ object database. Your mount contains the following catalogs in its database:
  - Solar System – All 7 planets in our Solar System plus the Moon, Sun and Pluto.
  - Stars – Custom lists of all the brightest stars, double stars, variable stars and asterisms.
  - Deep Sky – Custom lists of all the best galaxies, nebulae and clusters as well as the complete Messier and select NGC objects.
5. **Identify:** Searches the databases and displays the name and offset distances to the nearest matching objects.
6. **Menu:** Displays the many setup and utilities functions, such as tracking rate and user defined objects and many others.
7. **Option (Celestron Logo):** Can be used in combination with other keys to access more advanced features and functions.
8. **Enter:** Pressing **ENTER** allows you to select any of the functions, accept entered parameters and slew the telescope to displayed objects.
9. **Back:** Pressing **BACK** will take you out of the current menu and display the previous level of the menu path. Press **BACK** repeatedly to get back to a main menu or use to erase data entered by mistake.
10. **Sky Tour:** Activates the tour mode, which seeks out all the best objects in the sky and automatically slews the telescope to those objects.
11. **Scroll Keys:** Scrolls up and down within any of the menu lists. A double arrow symbol on the right side of the LCD indicates that the scroll keys can be used to view additional information.
12. **Motor Speed:** Slews the telescope faster or slower when the direction buttons are pressed.
13. **Object Info:** Displays coordinates and useful information about objects selected from the database.
14. **RS-232 Jack:** Allows you to connect your telescope to a computer, for use with software programs for point-and click slewing capability and updating firmware via PC.

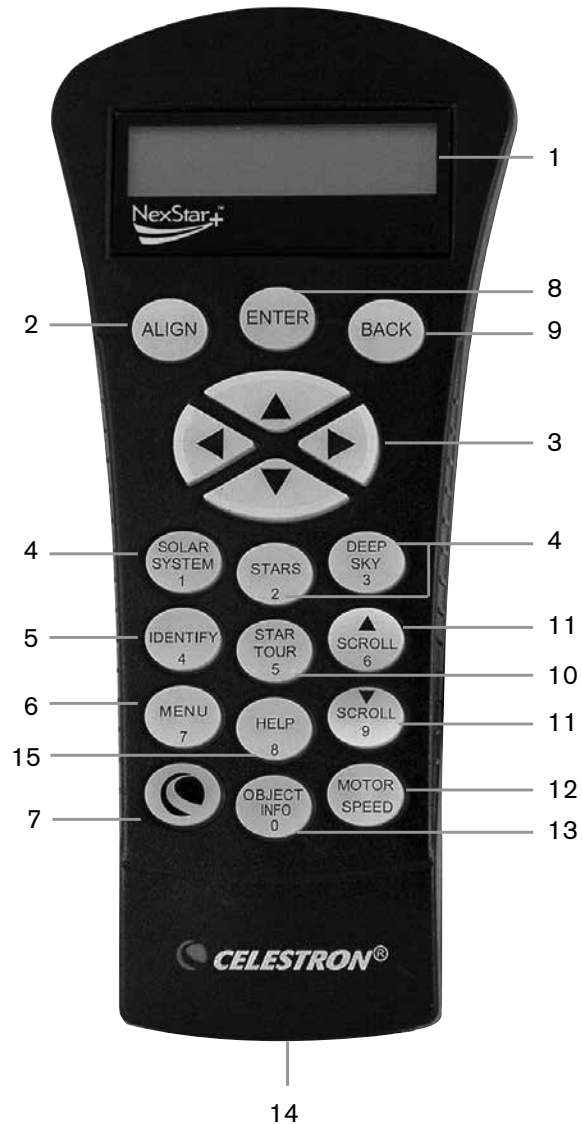

## ALIGNMENT PROCEDURES

---

For the telescope to accurately point to objects in the sky, it must first be aligned with known positions (stars). With this information, the telescope can create a model of the sky, which it uses to locate any object with known coordinates. There are many ways to align your telescope with the sky depending on what information the user is able to provide:

- **SkyAlign** works by aligning on any three bright stars or planets in the sky.
- **One Star Align** uses the entered time/location information and allows the user to select one alignment star. Provides a fast alignment, at the expense of less pointing accuracy.
- **Two Star Align** uses the entered time/location information and allows the user to select which two alignment stars the telescope will automatically slew to.
- **Auto Two Star Align** will display a list of visible daytime objects (planets and the Moon) available to align the telescope.
- **Solar System Align** will display a list of visible daytime objects (planets and the Moon) available to align the telescope.
- **Quick-Align** will ask you to input all the same information as you would for the Two Star Align procedure. However, instead of slewing to the alignment stars for centering and alignment, the telescope bypasses this step and simply models the sky based on the information given.
- **Last Alignment** restores your last saved star alignment and switch position. Last Alignment also serves as a good safeguard in case the telescope loses power.
- **EQ North / EQ South Alignment** is used when polar aligned on an optional equatorial wedge. Similar to the altazimuth alignments described earlier, the EQ alignments gives you the choice of performing an AutoAlign, Two-Star alignment, One-Star alignment or Solar System alignment.

## OVERVIEW OF TWO POPULAR ALIGNMENT METHODS

### ALIGNING WITH SKYALIGN

---

1. Flip the NexStar Evolution's power switch on. The hand control will display "Verifying Packages..." After a few seconds, it will display "Evolution." Press ENTER to choose SkyAlign or use the UP/DOWN scroll keys (10) to select a different method of alignment.
2. Press ENTER. You will be prompted to enter the local time in 24-hour format. Ex. 21:00 for 9PM.
3. Select Daylight Savings or Standard Time, toggle the 6 & 9 (up and down scrolling keys) to change.
4. Select time zone, then enter the date.
5. Press ENTER to begin SkyAlign. Use the arrow buttons on the hand control to slew (move) the telescope towards any bright celestial object in the sky. Center the object in the crosshairs of the finderscope and press ENTER.
6. If the finderscope has been properly aligned with the telescope tube, the alignment star should now be visible inside the field of view of the eyepiece. Center the star in the eyepiece using the direction keys on the hand controller and press the ALIGN button. This will accept the star as the first alignment position. (There is no need to adjust the slewing rate of the motors after each alignment step. The NexStar automatically selects the best slewing rate for aligning objects in both the finderscope and the eyepiece).
7. For the second alignment object, choose a bright star or planet as far as possible from the first alignment object. Once again, use the direction keys to center the object in the finderscope and press ENTER. Center the object in the eyepiece, then press the ALIGN button.
8. Repeat the process for the third alignment star. When the telescope has been aligned to the final stars, the display will read "Align Success."



## ALIGNING WITH AUTO TWO STAR

---

After the first star is selected and centered, the second star will automatically be chosen for the best possible alignment. Once selected, the telescope will automatically slew to the second alignment star to complete the alignment.

1. Flip the NexStar's power switch on. The hand control will display "Verifying Packages..." After a few seconds it will display "Evolution." Scroll down using the "9" Scroll key and press ENTER to choose Auto Two Star.
2. Press ENTER and you will be prompted to enter the local time in 24-hour format. Ex. 21:00 for 9PM.
3. Select Daylight Savings or Standard Time, toggle the 6 & 9 (up and down scrolling keys) to change.
4. Select time zone, then enter the date. Press ENTER each time to proceed to the next prompt.
5. The display will now prompt you to "Select Star 1" from the displayed list on the hand control. Use Up and Down scroll keys (6 and 9 on the keypad) to scroll to the desired star and then press ENTER.
6. Use the direction keys to slew the telescope to the star you selected. Center the star in the StarPointer and press ENTER. Finally, center the star in the eyepiece and press ALIGN.
7. The hand control will automatically display the most suitable second alignment star that is above the horizon. Press ENTER to automatically slew the telescope to the displayed star. If for some reason you do not wish to select this star (perhaps it is behind a tree or building), you can either:
  - Press the UNDO button to display the next most suitable star for alignment.
  - Use the UP and DOWN scroll keys to manually select any star you wish from the entire list of available stars.
8. Repeat the same process of centering the star in your StarPointer, press ENTER, then center in your eyepiece and press ALIGN.

When the telescope has been aligned to both stars the display will read Alignment Success. You are now ready to find your first object.

## USING A WEDGE WITH EQ NORTH / EQ SOUTH ALIGNMENT

EQ North and EQ South Alignments assist the user in aligning the telescope when polar aligned on an optional equatorial wedge.

### EQ AUTOALIGN

---

1. Select EQ North (for northern hemisphere) or South (for southern hemisphere) Align from the alignment options and press ENTER.
2. Enter time, date, and location information as with all other alignments.
3. Select EQ AutoAlign method and press ENTER
4. Use the direction arrow keys to move the telescope until the altitude and meridian index markers are aligned. The altitude index marker is located at the top of the fork arm, and the meridian marker is on the base of the fork arm. The tube should be perpendicular to the fork arm and facing the meridian.
5. The display will now prompt you to "Select Star 1" from the displayed list on the hand control. Use Up and Down scroll keys (6 and 9 on the keypad) to scroll to the desired star and then press ENTER.
6. Use the direction keys to slew the telescope to the star you selected. Center the star in the StarPointer and press ENTER. Finally, center the star in the eyepiece and press ALIGN.
7. The hand control will automatically display the most suitable second alignment star that is above the horizon. Press ENTER to automatically slew the telescope to the displayed star. If for some reason you do not wish to select this star (perhaps it is behind a tree or building), you can either:
  - Press the UNDO button to display the next most suitable star for alignment.
  - Use the UP and DOWN scroll keys to manually select any star you wish from the entire list of available stars.
8. Repeat the same process of centering the star in your StarPointer, press ENTER, then center in your eyepiece and press ALIGN.

When the telescope has been aligned to both stars the display will read Alignment Success. You are now ready to find your first object. Tracking will now occur equatorially, moving in just one direction to keep the object centered in the telescope's field of view without rotating. This tracking is suitable for astroimaging.

# NEXSTAR EVOLUTION TELESCOPE SETTINGS IN NEXSTAR+ HAND CONTROL

Press Menu, scroll to the "Peripherals" menu and press ENTER. Here, you can control L.E.D. brightness of the logo lights and accessory tray lighting, check the battery status, or set more advanced features including external power supply and USB charge port settings.

## ADJUST THE L.E.D. BRIGHTNESS

---

1. Scroll to "Mount Lights" and press ENTER.
2. Scroll to select Tray Light, WiFi Light, or Logo Light and press ENTER.
3. Select a brightness value from 0-10, 0 being OFF, and 10 being fully lit. Press ENTER and the new brightness setting will take effect.

## POWER

---

1. Scroll to "Power" and press ENTER.
2. Scroll to select "Status" or "External Power" and press ENTER.
  - Status will display the battery voltage, if the battery charge state is High, Medium, or Low, and if the battery is charging or discharging.
  - External Power allows you to select a higher input current if you are using a higher capacity power supply. Values can be between 2 and 5 amperes as specified on your power supply. Do not change this setting unless you are using a larger capacity supply. The included power supply should always be set to 2.0A.

## WIFI

---

1. Scroll to "WiFi" and press ENTER.
2. Scroll to select "Status" or "Enable/Disable" and press ENTER
  - Status will display the WiFi mode, Direct Connect or Access Point, and whether or not the WiFi is connected to a network.
  - Enable/Disable will optionally allow you to disable the WiFi broadcast. The WiFi L.E.D. will shut off indicating it has been disabled. Every time you power off and on the mount again, this setting defaults to Enabled.

## USB CHARGE PORT

---

1. Scroll to "Charge Port" and press ENTER.
2. Press ENTER to toggle between "Automatic" or "Always On". "Always On" keeps the charge port going, even in a low battery condition. "Automatic" automatically disables the USB Charge Port when battery power is low.

# NEXSTAR+ HAND CONTROL FOR NEXSTAR EVOLUTION MENU TREE

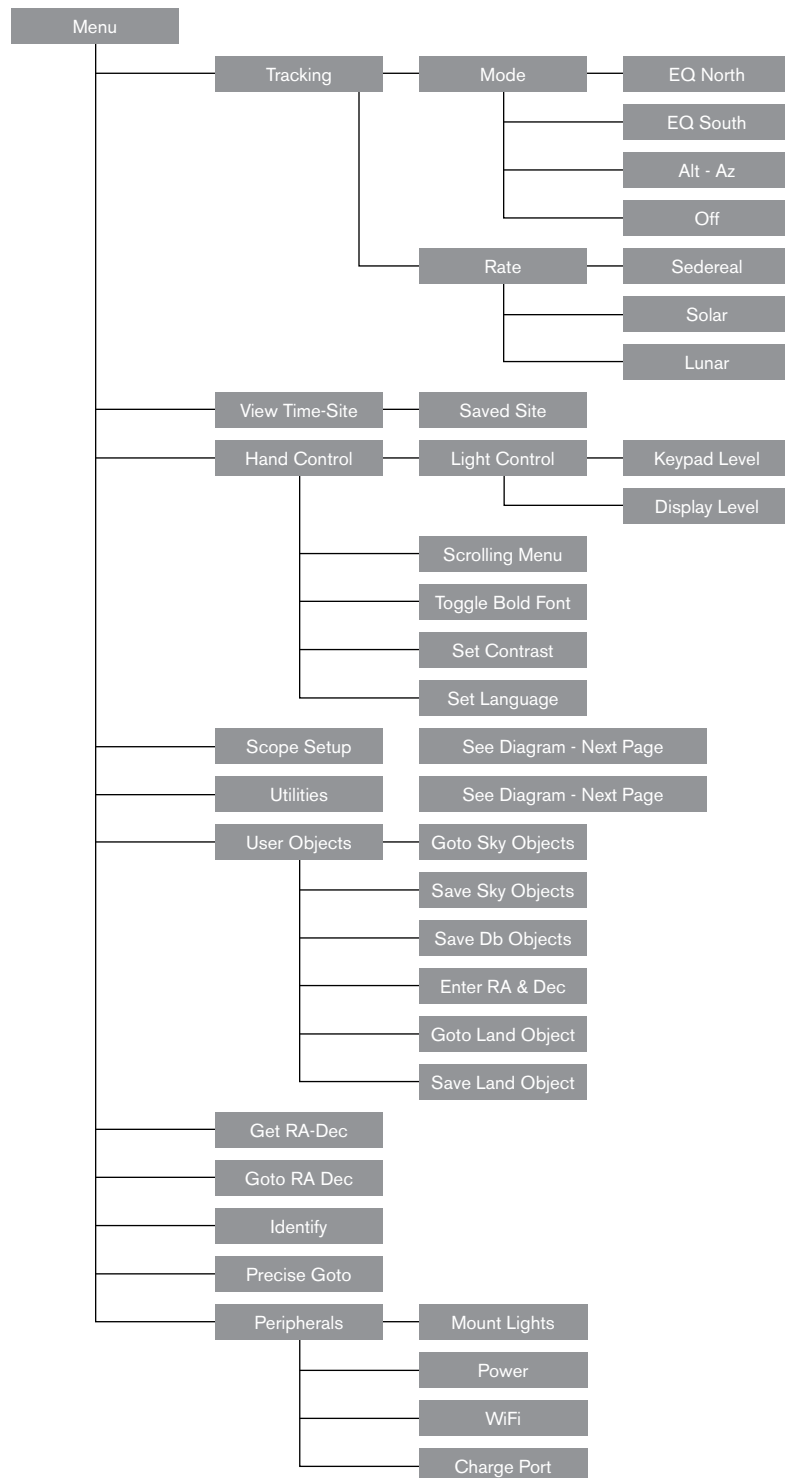

# ADVANCED MENU TREE

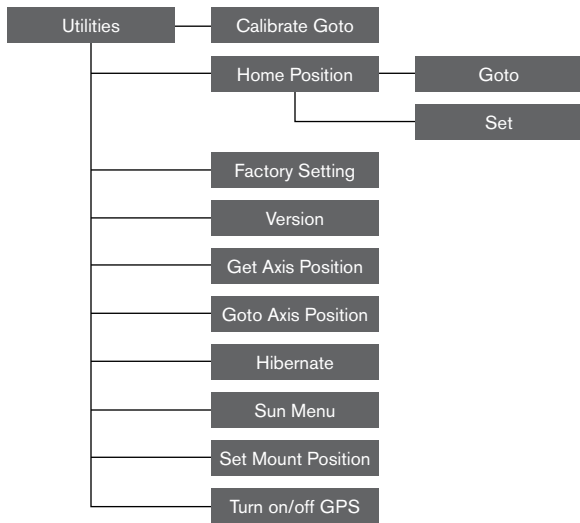
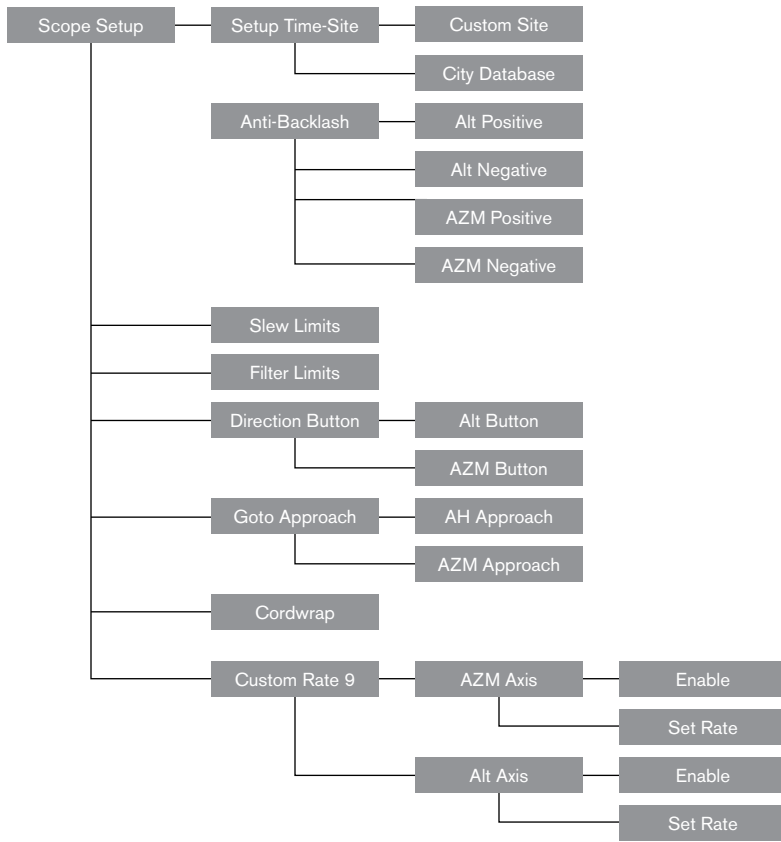

# TELESCOPE MAINTENANCE

Your NexStar Evolution telescope requires little maintenance. There are a few things to remember that will ensure your telescope performs at its best.

## DEW PREVENTION

---

Schmidt-Cassegrain telescopes are especially susceptible to condensation forming on the front corrector lens because the glass is immediately exposed to the outside air, just like the windshield on your car. If the temperature outside drops below the dew point, dew may form on the corrector within minutes.

The easiest way to prevent dew is to add an optional dew shield, available from Celestron, which shrouds the corrector and keeps the air immediately surrounding the corrector slightly warmer than the ambient temperature. If conditions are more severe, a dew heater, commonly available from other manufacturers, can be added to apply slight heat to the corrector lens to keep it dry all night.

If dew has already formed on the corrector, point the telescope downward and allow the telescope to dry. You can also use a hairdryer to heat the corrector and evaporate the moisture to dry the telescope.

Dew does not harm the telescope, but can lead to faster dust build up. You should only cap the telescope when it's dry. Do not store the telescope if covered in dew. Allow the telescope to dry first.

## CARE AND CLEANING OF THE OPTICS

---

Occasionally, dust and/or moisture may build up on the corrector plate of your telescope. Special care should be taken when cleaning any instrument so as not to damage the optics.

If dust has built up on the corrector plate, remove it with a brush (made of camel's hair) or a can of pressurized air. Spray at an angle to the lens for approximately two to four seconds. Then, use an optical cleaning solution and white tissue paper to remove any remaining debris. Apply the solution to the tissue and then apply the tissue paper to the lens. Low pressure strokes should go from the center of the corrector to the outer portion. Do NOT rub in circles!

You can use a commercially made lens cleaner or mix your own. A good cleaning solution is isopropyl alcohol mixed with distilled water. The solution should be 60% isopropyl alcohol and 40% distilled water. Or, liquid dish soap diluted with water (a couple of drops per one quart of water) can be used.

If moisture condenses on the inside of the corrector, remove the accessories from the rear cell of the telescope. Place the telescope in a dust-free environment and point it down. This will remove the moisture from the telescope tube.

To minimize the need to clean your telescope, replace all lens covers once you have finished using it. Since the rear cell is NOT sealed, the cover should be placed over the opening when not in use. This will prevent contaminants from entering the optical tube.

Internal adjustments and cleaning should be done only by the Celestron repair department. If your telescope is in need of internal cleaning, please call the factory for a return authorization number and price quote.

## COLLIMATION

---

The optical performance of your telescope is directly related to its collimation. Collimation is the alignment of the optical system. Your Schmidt-Cassegrain telescope was collimated at the factory after it was completely assembled. However, the telescope may have to be collimated after it's transported. The only optical element that may need to be adjusted, or is possible, is the tilt of the secondary mirror.

To check the collimation of your telescope you will need a light source. A bright star near the zenith is ideal since there is a minimal amount of atmospheric distortion. Make sure that tracking is on so that you won't have to manually track the star. Or, if you do not want to power up your telescope, you can use Polaris. Its position relative to the celestial pole means that it moves very little thus eliminating the need to manually track it.

Before you begin the collimation process, be sure that your telescope is in thermal equilibrium with the surroundings. Allow 45 minutes for the telescope to reach equilibrium if you move it between large temperature extremes.

To verify collimation, view a star near the zenith. Use a medium to high power eyepiece. It is important to center a star in the center of the field to judge collimation. Slowly move in and out of focus and judge the symmetry of the star. If you see a systematic skewing of the star to one side, then re-collimation is needed.

To accomplish this, you need to adjust the secondary collimation screw(s) that move the star across the field toward the direction of the skewed light. These screws are located on the secondary mirror holder.

**Note:** Make only small 1/6 to 1/8 adjustments to the collimation screws and re-center the star by moving the scope before making any improvements or before making further adjustments.

1. While looking through a medium to high power eyepiece, de-focus a bright star until a ring pattern with a dark shadow appears. Center the de-focused star and notice in which direction the central shadow is skewed.



**Secondary Mirror Collimation Adjustment Screws**



**Even though the star pattern appears the same on both sides of focus, they are asymmetric. The dark obstruction is skewed off to the left side of the diffraction pattern indicating poor collimation.**

2. Place your finger along the edge of the front cell of the telescope (be careful not to touch the corrector plate), pointing towards the collimation screws. The shadow of your finger should be visible when looking into the eyepiece. Rotate your finger around the tube edge until its shadow is seen closest to the narrowest portion of the rings (i.e., the same direction in which the central shadow is skewed)
3. Locate the collimation screw closest to where your finger is positioned. This will be the collimation screw you will need to adjust first. (If your finger is positioned exactly between two of the collimation screws, then you will need to adjust the screw opposite where your finger is located).
4. Use the hand control buttons to move the de-focused star image to the edge of the field of view in the same direction that the central obstruction of the star image is skewed.
5. While looking through the eyepiece, use an Phillips head screw driver to turn the collimation screw you located in step 2 and 3. Usually a tenth of a turn is enough to notice a change in collimation. If the star image moves out of the field of view in the direction that the central shadow is skewed, than you are turning the collimation screw the wrong way. Turn the screw in the opposite direction, so that the star image is moving towards the center of the field of view.
6. If while turning you notice that the screws get very loose, then simply tighten the other two screws by the same amount. Conversely, if the collimation screw gets too tight, then loosen the other two screws by the same amount.
7. Once the star image is in the center of the field of view, check to see if the rings are concentric. If the central obstruction is still skewed in the same direction, then continue turning the screw(s) in the same direction. If you find that the ring pattern is skewed in a different direction, than simply repeat steps 2 through 6 as described above for the new direction.

Perfect collimation will yield a star image very symmetrical just inside and outside of focus. In addition, perfect collimation delivers the optimal optical performance specifications that your telescope is built to achieve.

If seeing (i.e., air steadiness) is turbulent, collimation is difficult to judge. Wait until a better night if it is turbulent or aim to a steadier part of the sky. Stars in a steady part of the sky will be still, not twinkling.

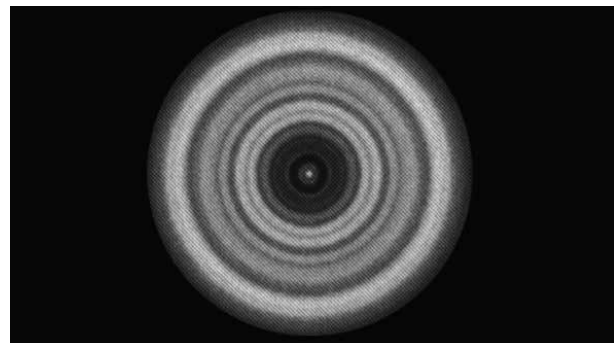

**A collimated telescope should appear symmetrical with the central obstruction centered in the star's diffraction pattern.**

## APPENDIX A: SPECIFICATIONS

<b>Mount</b>	
<b>Mount Type</b>	Computerized Altitude-Azimuth
<b>Worm Gears</b>	Brass worm gears with ball bearings
<b>Worm Wheels</b>	Stainless steel 146mm diameter, 180 teeth
<b>Internal Battery</b>	9.6V, 4.5Ah lithium iron phosphate battery (LiFePO4)
<b>Max Power Consumption</b>	Up to 4.5A with optional power supply if battery charge, USB charge port, and telescope are used simultaneously.
<b>Min Power Consumption</b>	0.0001A
<b>AUX Ports</b>	4 AUX ports, compatible with NexStar+ Hand Control, StarSense AutoAlign and other accessories.
<b>USB Charge Port</b>	5V, Max Output 2.0A
<b>Power Input Port</b>	12VDC, tip positive, accepts up to 5.0A of current
<b>Included Power Supply</b>	USA, EU, UK, and AU Input Plugs included, 12VDC 2.0A output

<b>NexStar Evolution 6 Telescope</b>	
<b>Optical Design</b>	Schmidt-Cassegrain
<b>Aperture</b>	150 mm
<b>Focal Length</b>	1500 mm
<b>Focal Ratio</b>	10
<b>Focal Length of Eyepiece 1</b>	40 mm
<b>Focal Length of Eyepiece 2</b>	13 mm
<b>Magnification of Eyepiece 1</b>	38x
<b>Magnification of Eyepiece 2</b>	115x
<b>Finderscope</b>	StarPointer, uses 3V CR2032 lithium button battery
<b>Star Diagonal</b>	1.25"
<b>Highest Useful Magnification</b>	354x
<b>Lowest Useful Magnification</b>	21x
<b>Limiting Stellar Magnitude</b>	13.4
<b>Resolution (Rayleigh)</b>	0.93 arc seconds
<b>Resolution (Dawes)</b>	0.77 arc seconds
<b>Light Gathering Power (Compared to human eye)</b>	459x
<b>Secondary Mirror Obstruction</b>	2.2 in
<b>Secondary Mirror Obstruction by Area</b>	14%
<b>Secondary Mirror Obstruction by Diameter</b>	37%
<b>Optical Coatings</b>	StarBright XLT
<b>Optical Tube Length</b>	16 in

## NexStar Evolution 8 Telescope

<b>Optical Design</b>	Schmidt Cassegrain
<b>Aperture</b>	203.2 mm
<b>Focal Length</b>	2032 mm
<b>Focal Ratio</b>	10
<b>Focal Length of Eyepiece 1</b>	40 mm
<b>Focal Length of Eyepiece 2</b>	13 mm
<b>Magnification of Eyepiece 1</b>	51x
<b>Magnification of Eyepiece 2</b>	156x
<b>Finderscope</b>	StarPointer, uses 3V CR2032 lithium button battery
<b>Star Diagonal</b>	1.25"
<b>Highest Useful Magnification</b>	480x
<b>Lowest Useful Magnification</b>	29x
<b>Limiting Stellar Magnitude</b>	14
<b>Resolution (Rayleigh)</b>	0.69 arc seconds
<b>Resolution (Dawes)</b>	0.57 arc seconds
<b>Light Gathering Power (Compared to human eye)</b>	843x
<b>Secondary Mirror Obstruction</b>	2.5 in (64 mm)
<b>Secondary Mirror Obstruction by Area</b>	9.77%
<b>Optical Coatings</b>	StarBright XLT
<b>Optical Tube Length</b>	17 in



## NexStar Evolution 9.25 Telescope

<b>Optical Design</b>	Schmidt-Cassegrain
<b>Aperture</b>	235 mm
<b>Focal Length</b>	2350 mm
<b>Focal Ratio</b>	10
<b>Focal Length of Eyepiece 1</b>	40 mm
<b>Focal Length of Eyepiece 2</b>	13 mm
<b>Magnification of Eyepiece 1</b>	59x
<b>Magnification of Eyepiece 2</b>	180x
<b>Finderscope</b>	StarPointer
<b>Star Diagonal</b>	1.25"
<b>Highest Useful Magnification</b>	555x
<b>Lowest Useful Magnification</b>	34x
<b>Limiting Stellar Magnitude</b>	14.4
<b>Resolution (Rayleigh)</b>	0.59 arc seconds
<b>Resolution (Dawes)</b>	0.49 arc seconds
<b>Light Gathering Power (Compared to human eye)</b>	1127x
<b>Optical Coatings</b>	StarBright XLT
<b>Secondary Mirror Obstruction</b>	3.35 in (85 mm)
<b>Secondary Mirror Obstruction by Diameter</b>	36%
<b>Secondary Mirror Obstruction by Area</b>	13%
<b>Optical Tube Length</b>	22 in

## APPENDIX B: ADVANCED WIFI

### SETTING UP ACCESS POINT MODE

Access Point allows the telescope to connect to an existing WiFi network, allowing you to share multiple devices on one network. This is especially useful if you want to connect to a home network with internet and control the telescope at the same time.

1. Keep the WiFi switch in the UP position for direct connect.
2. Connect to the WiFi network "SkyQLink-xx".
3. Open SkyPortal, tap Settings, then tap Telescope Communication.
4. Tap Configure Access Point. Enter the network settings for your network. Enter the exact SSID (or the network broadcast name). Enable DHCP Client if applicable to your network, otherwise you will have to enter the IP Address, Subnet mask, and Gateway for your particular network.
5. When complete, tap Send Configuration to SkyQ Link. A message will appear if SkyQ Link was successfully configured.
6. Move the WiFi switch to the DOWN position on the telescope. This switches the WiFi to Access Point mode.
7. Connect to your network with your smart device.
8. Open Navigator, tap Settings, then tap Telescope Communication, and select "Use Access Point". Tap Done when complete.
9. Connect to the telescope in SkyPortal, and the connection will now be enabled through your WiFi network.

## APPENDIX C: L.E.D. STATUS

Refer to this chart to understand the different L.E.D. statuses when the telescope is powered on.

<b>L.E.D. Status</b>					
<b>Celestron Power Logo, ON</b>	<b>Celestron Power Logo, Slow Pulse</b>	<b>Celestron Power Logo, Blink</b>	<b>WiFi Logo Blink</b>	<b>WiFi Logo, Slow Pulse</b>	<b>WiFi Logo Steady ON</b>
Normal operation	Plugged in, charging	Low Battery	Seeking connection	Connected to WiFi only	Connected to app
Fully Charged when plugged in		When power is plugged in, momentarily blinks			
		Fast blink – error, consult Celestron technical support.			

## CELESTRON TWO YEAR LIMITED WARRANTY

A. Celestron warrants your telescope mount to be free from defects in materials and workmanship for two years. Celestron will repair or replace such product or part thereof which, upon inspection by Celestron, is found to be defective in materials or workmanship. As a condition to the obligation of Celestron to repair or replace such product, the product must be returned to Celestron together with proof-of-purchase satisfactory to Celestron.

B. The Proper Return Authorization Number must be obtained from Celestron in advance of return. Call Celestron at (310) 328-9560 to receive the number to be displayed on the outside of your shipping container.

All returns must be accompanied by a written statement setting forth the name, address, and daytime telephone number of the owner, together with a brief description of any claimed defects. Parts or product for which replacement is made shall become the property of Celestron.

The customer shall be responsible for all costs of transportation and insurance, both to and from the factory of Celestron, and shall be required to prepay such costs.

Celestron shall use reasonable efforts to repair or replace any telescope mount covered by this warranty within thirty days of receipt. In the event repair or replacement shall require more than thirty days, Celestron shall notify the customer accordingly. Celestron reserves the right to replace any product which has been discontinued from its product line with a new product of comparable value and function.

This warranty shall be void and of no force of effect in the event a covered product has been modified in design or function, or subjected to abuse, misuse, mishandling or unauthorized repair. Further, product malfunction or deterioration due to normal wear is not covered by this warranty.

CELESTRON DISCLAIMS ANY WARRANTIES, EXPRESS OR IMPLIED, WHETHER OF MERCHANTABILITY OF FITNESS FOR A PARTICULAR USE, EXCEPT AS EXPRESSLY SET FORTH HEREIN. THE SOLE OBLIGATION OF CELESTRON UNDER THIS LIMITED WARRANTY SHALL BE TO REPAIR OR REPLACE THE COVERED PRODUCT, IN ACCORDANCE WITH THE TERMS SET FORTH HEREIN. CELESTRON EXPRESSLY DISCLAIMS ANY LOST PROFITS, GENERAL, SPECIAL, INDIRECT OR CONSEQUENTIAL DAMAGES WHICH MAY RESULT FROM BREACH OF ANY WARRANTY, OR ARISING OUT OF THE USE OR INABILITY TO USE ANY CELESTRON PRODUCT. ANY WARRANTIES WHICH ARE IMPLIED AND WHICH CANNOT BE DISCLAIMED SHALL BE LIMITED IN DURATION TO A TERM OF TWO YEARS FROM THE DATE OF ORIGINAL RETAIL PURCHASE.

Some states do not allow the exclusion or limitation of incidental or consequential damages or limitation on how long an implied warranty lasts, so the above limitations and exclusions may not apply to you.

This warranty gives you specific legal rights, and you may also have other rights which vary from state to state.

Celestron reserves the right to modify or discontinue, without prior notice to you, any model or style telescope.

If warranty problems arise, or if you need assistance in using your telescope mount contact:

CELESTRON, LLC.

Customer Service Department

2835 Columbia Street

Torrance, CA 90503

Tel. 800.421.9649

Monday-Friday 8AM-4PM PST

**NOTE:** This warranty is valid to U.S.A. and Canadian customers who have purchased this product from an authorized Celestron dealer in the U.S.A. or Canada. Warranty outside the U.S.A. and Canada is valid only to customers who purchased from a Celestron's International Distributor or Authorized Celestron Dealer in the specific country. Please contact them for any warranty service.

**FCC Note:** This equipment has been tested and found to comply with the limits for a Class B digital device, pursuant to part 15 of the FCC Rules. These limits are designed to provide reasonable protection against harmful interference in a residential installation. This equipment generates, uses, and can radiate radio frequency energy and, if not installed and used in accordance with the instructions, may cause harmful interference to radio communications. However, there is no guarantee that interference will not occur in a particular installation. If this equipment does cause harmful interference to radio or television reception, which can be determined by turning the equipment off and on, the user is encouraged to try to correct the interference by one or more of the following measures:

- Reorient or relocate the receiving antenna.
- Increase the separation between the equipment and receiver.
- Connect the equipment into an outlet on a circuit different from that to which the receiver is connected.
- Consult the dealer or an experienced radio/TV technician for help.

Product design and specifications are subject to change without prior notification.

This product is designed and intended for use by those 14 years of age and older.



### Battery Warnings

Read all instructions and warnings prior to using this product. Improper use of this product may result in product damage, excess heat, toxic fumes, fire or explosion, for which damages you ("Purchaser"), and not Celestron (collectively "Manufacturer") are responsible.

- Do not store battery in high temperature environment, including intense sunlight heat. Do not place battery in fire or other excessively hot environments.
- Be cautious of excessive drops, bumps, abrasions or other impacts to this battery. If there is any damage to the battery such as dents, punctures, tears, deformities or corrosion, due to any cause, discontinue use and contact manufacturer or dispose of it in an appropriate manner at your local battery recycling center.
- Do not disassemble this battery or attempt to repair or modify it in any manner.
- Do not expose this battery to moisture or submerge it in liquid. Keep battery dry at all times.
- Do not attempt to replace any part of this battery (replacing the entire battery is OK).
- This battery is intended for adult use only. If this battery is intended by Purchaser to be used by a minor, purchasing adult agrees to provide detailed instructions and warnings to any minor prior to use. Failure to do so is sole responsibility of purchaser, who agrees to indemnify Manufacturer for any unintended use/misuse by a minor.
- All batteries have gone through a thorough quality assurance inspection. If you find that your battery is excessively hot, is emitting odor, is deformed, abraded, cut or is experiencing or demonstrating an abnormal phenomenon, immediately stop all battery use and contact the Manufacturer.
- For extended storage, first charge your battery for at least one hour.
- Never dispose of batteries in the garbage. Disposal of batteries in the garbage is unlawful, in The United States, under state and federal environmental laws and regulations. Always take used batteries to your local battery-recycling center.

**DISCLAIMER:** This Battery is meant for use only in conjunction with the appropriate electronic devices. Please consult your device packaging to determine whether this Battery is compatible with your particular mobile device. Manufacturer is not responsible for any damages to any device incurred through the use of this product.

Manufacturer shall not in any way be liable to you or to any third party for any damages you or any third party may suffer as a result of use, intended or unintended, or misuse of this battery in conjunction with any device or accessory. Manufacturer will not be responsible for any damages you or any third party may suffer as a result of misuse of this battery as outlined above.

©2018 Celestron • All rights reserved.  
www.celestron.com  
2835 Columbia Street • Torrance, CA 90503 U.S.A.  
Telephone: 800.421.9649

**celestron.com**